



POWER AMPLIFIER TESTING FOR 802.11AC



Using ZT8201 RF Test Set & ZProtocol™ WLAN Software

INTRODUCTION

The first Wireless LAN (WLAN) standards were used primarily to provide low data rate wireless connectivity to a wired broadband connection for web browsing and email. Over time, new 802.11 wireless protocols were adopted to offer higher data rates for new applications. Table 1 shows the progression of the 802.11 WLAN standards.

The latest 802.11ac WLAN standard, which is still in draft format, will achieve up to 867 Mbps data rate over a single RF channel, and up to 6.93 Gbps using MIMO channels. These high 802.11ac data rates are accomplished by extending the 802.11n standard with more instantaneous bandwidth (up to 160 MHz), more MIMO channels (up to 8), and higher density modulation constellations (up to 256QAM). Within this paper, we examine the demands that these new requirements place upon the design validation, characterization and testing of power amplifiers for 802.11ac.

802.11 protocol	Release	Frequency (GHz)	Bandwidth (MHz)	Data rate per stream (Mbit/s)	MIMO streams	Modulation
- (obsolete)	Jun 1997	2.4	20	1 - 2	1	DSSS, FHSS
a	Sep 1999	5, 3.7	20	6 - 54	1	OFDM
b	Sep 1999	2.4	20	5.5 - 11	1	DSSS
g	Jun 2003	2.4	20	6 - 54	1	OFDM, DSSS
n	Oct 2009	2.4, 5	20	6.5 - 72.2	1 - 4	OFDM
			40	13.5 - 150		
ac (draft)	Nov 2011	5	20	6.5 - 86.7	1 - 8	OFDM
			40	13.5 - 200		
			80	29.3 - 433.3		
			160	58.5 - 866.7		

Table 1) 802.11 WLAN Protocols

POWER AMPLIFIER TESTING

The power amplifier (PA) is a critical component within a WLAN transmitter circuit because PA performance affects wireless coverage area, data rate capacity, and battery life. The goal for any transmitter PA is to generate sufficient linear RF output power while using as little DC power as possible. PA performance can dominate the system-level WLAN transmitter performance due to PA non-linear distortion as the output power level increases into the amplifier's gain compression region. Mobile devices and wireless access points typically transmit between 100 mW (+20 dBm) and 1 W (+30 dBm) of RF output power, and the PA must be able to generate sufficient power with minimal non-linear distortion. For PA testing, the complete set of IEEE 802.11ac specified transmitter compliance tests apply, including [1]:

- Spectrum Mask
- Spectral Flatness
- Peak Power
- Center Frequency Error
- Symbol Clock Frequency Error
- Center Frequency Leakage
- Error Vector Magnitude (EVM)

This paper further expands upon Error Vector Magnitude (EVM) testing, a comprehensive and widely used technique for PA testing [2-3]. EVM is a measurement used to quantify the performance of a digital communication channel, and provides a measure of the deviation of captured encoded data symbols from their ideal locations within the I/Q constellation. The root mean square EVM is a comprehensive measurement that is degraded by any imperfection in the RF signal or device. For a WLAN transmitter design, the PA requires an acceptable EVM contribution over its full operating range of output power levels and channel frequencies. Because 802.11ac includes 256QAM constellations with a 2.5% (-32dB) EVM specification limit, the PA linearity and corresponding EVM contribution requirements are more stringent than earlier 802.11 standards. Whereas the EVM contribution of a PA for 802.11n was limited to around 3%, the EVM contribution of the PA is limited to around 1.5% for 802.11ac [4]. In addition, the new 256QAM signal modulation has a higher peak-to-average ratio (PAR) which also increases the linear output power necessary for a PA within an 802.11ac transmitter design.

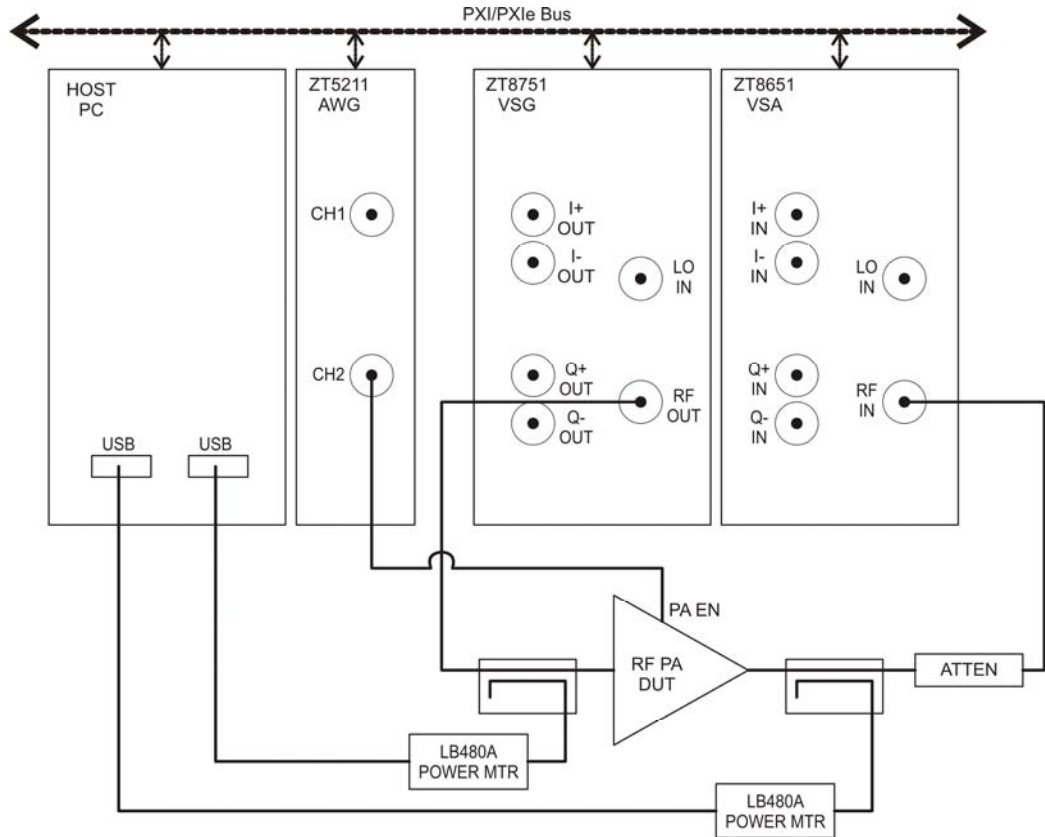

Figure 1) Test equipment block diagram for PA testing

Figure 1 shows a block diagram of a typical test setup for PA testing using ZTEC Instruments' ZT8201 RF test set. The typical equipment list includes:

- ZT8651 6 GHz Vector Signal Analyzer (VSA), 80 or 160 MHz analysis bandwidth options
- ZT8751 6 GHz Vector Signal Generator (VSG), 250 or 500 MHz modulation bandwidth options
- ZT5211 200MS/s Arbitrary Waveform Generator
- Optional Ladybug Technologies LB480A USB Power Meter(s)
- PXI/PXIe chassis & host computer
- Cables, directional coupler(s) & attenuator(s)

The USB Power Meters and associated directional couplers are optional because the PA input and output power levels are set and measured by the VSG and VSA. The power meters provide more precise calibrated measurements of the PA input and output power measured at the device-under-test (DUT) with directional couplers. Whereas the VSA and VSG are typically accurate to < 0.5 dB, the power meter provides accuracies to < 0.1 dB. Correction factors for the attenuator(s) must be pre-calibrated, and for the directional couplers when using the Power Meter configuration.

PA EVM

A typical EVM test for a PA will measure EVM versus PA output power over a number of test frequencies. Figure 2 shows actual measured data plots for a typical PA EVM test using the ZT8201 RF Test Set. The plots show all five 80 MHz 802.11ac channel frequencies tested over a 30 dB range on the input power applied to the PA. The actual PA output power is measured using a power meter and provides the data for the horizontal axis of the plot in figure 2. In this test, there are 5 channel frequencies and 30 power levels for a total of 150 test points. An advantage of the highly-integrated test equipment architecture of PXI/PXIe is the fast data throughput and processing speeds. With 150 test conditions, the total test time can be significantly reduced over other test equipment with interfaces such as LAN or GPIB. For the ZT8201 RF Test Set and ZProtocol™ WLAN software, example code is provided that optimizes setup and operation for 802.11ac testing to as fast as 20 ms per EVM measurement.

When examining the actual PA test data shown in figure 2, note that EVM degradation occurs at high output power levels. As the PA output power level increases into its gain compression region, non-linear distortion occurs and causes an increase in EVM. This EVM power sweep test identifies the linear power region for the PA, which is critical for WLAN transmitter design considerations. Note that in order to achieve the threshold of less than 1.5% EVM for 802.11ac, this particular PA can achieve a maximum of +10 dBm linear output power. Whereas this PA was designed and works well for 802.11n transmitters, its linear output power is not sufficiently for an 802.11ac transmitter design without additional linearization techniques such as digital pre-distortion.

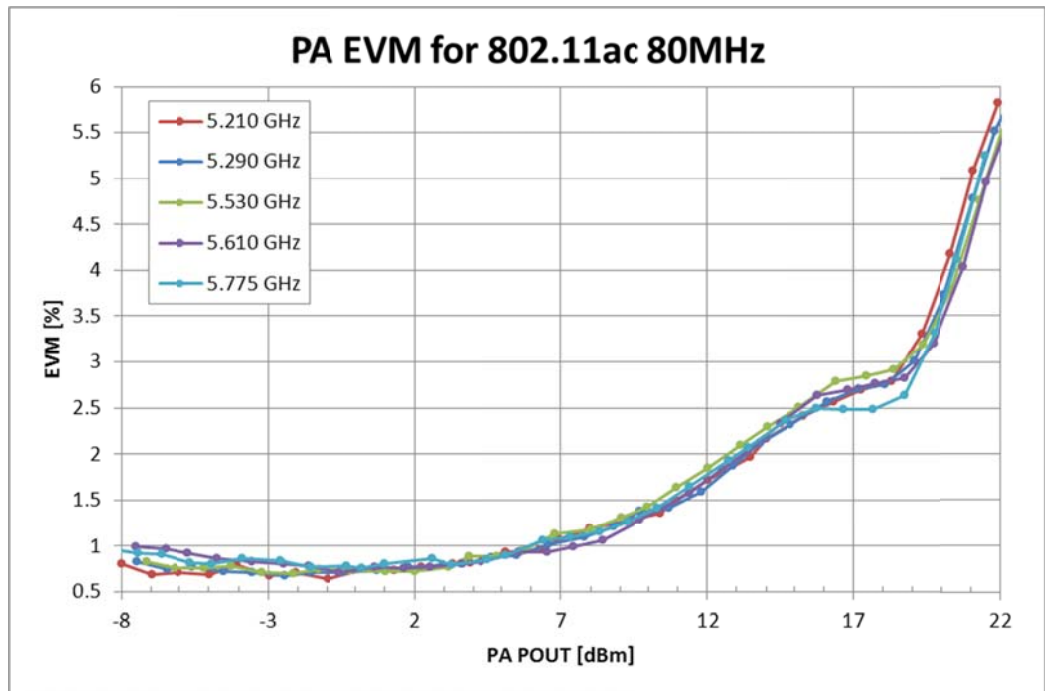

Figure 2) PA EVM versus Output Power

DYNAMIC EVM

Battery life and power consumption are important considerations for a system-level WLAN transmitter design. Because the transmit PA consumes a significant portion of the total system DC power, a number of techniques are employed to reduce PA power usage. Many PAs offer an adjustable DC supply voltage to optimize the maximum RF output power level versus its DC power consumption. Also, most PAs can be powered-down or disabled when not in use to conserve power, such as while receiving or between packets during transmission. In order to maximize power efficiency, the PA must have fast turn-on and turn-off switching times. Figure 3 shows the relative timing of the PA Enable (PA EN) and RF signal for a PA in pulsed operation with 50% duty cycle. Notice that the adjustable delay between the PA EN pulse and the RF signal is set to 2.0096 μs within this test setup. The highest DC power efficiency occurs when the time delta between PA EN and the RF signal is minimized, but a short delay can exacerbate transient effects on the RF signal.

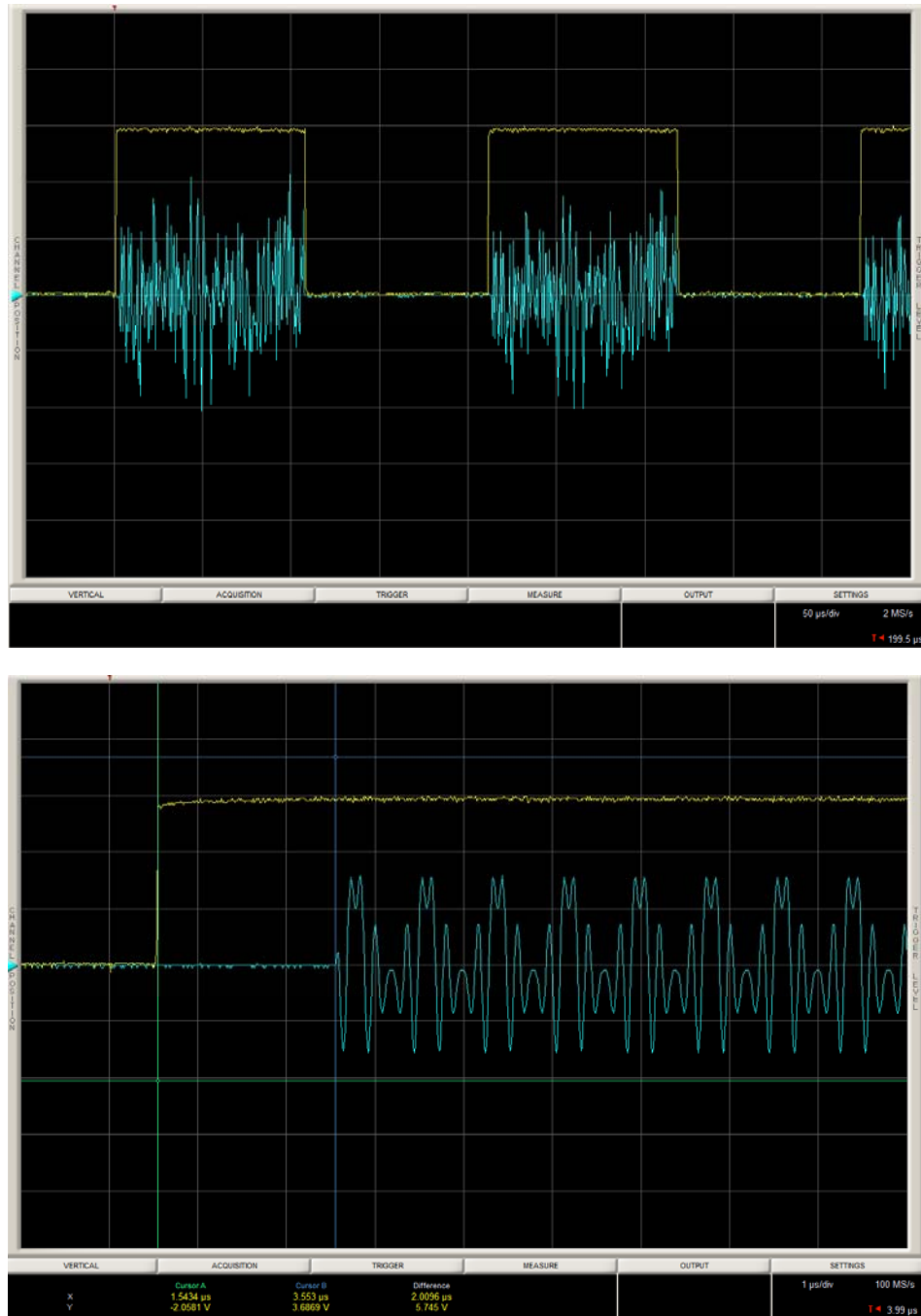

Figure 3) Time Domain Plots of PA Enable (yellow) and RF Pulse (blue)

Because the power-up/power-down operation of the PA can cause transient and thermal effects that degrade transmitter performance, another metric called dynamic EVM is often tested. Dynamic EVM is measured with a square wave pulse applied to PA EN to emulate the actual dynamic operation conditions of the transmitter. The degradation in dynamic EVM is due to the PA transient response affecting the preamble at the start of the packet and causing an imperfect channel estimate. Studies have shown that dynamic EVM with a 50% duty cycle square wave applied to PA EN to be worse than the static EVM (PA EN with 100% duty cycle) [5].

Using the test equipment shown in figure 1, dynamic EVM testing is completely automated with the PXI/PXIe system. All time synchronization for the dynamic EVM measurement is accomplished using the PXI/PXIe backplane trigger and clock signals. The block diagram of figure 1 shows the ZT5211 arbitrary waveform generator (AWG) that generates the PA EN pulse with an adjustable voltage magnitude, pulse width, pulse delay and repetition rate. The actual PA test data of figure 4 shows dynamic EVM to be worse than the static EVM up to +18 dBm output power. For this particular PA, dynamic EVM is better than static EVM above +18 dBm output power. As noted previously, this type of PA dynamic EVM measurement is important for transmitter design considerations because dynamic EVM measures the performance of the PA as it is used within the actual pulsed operating mode.

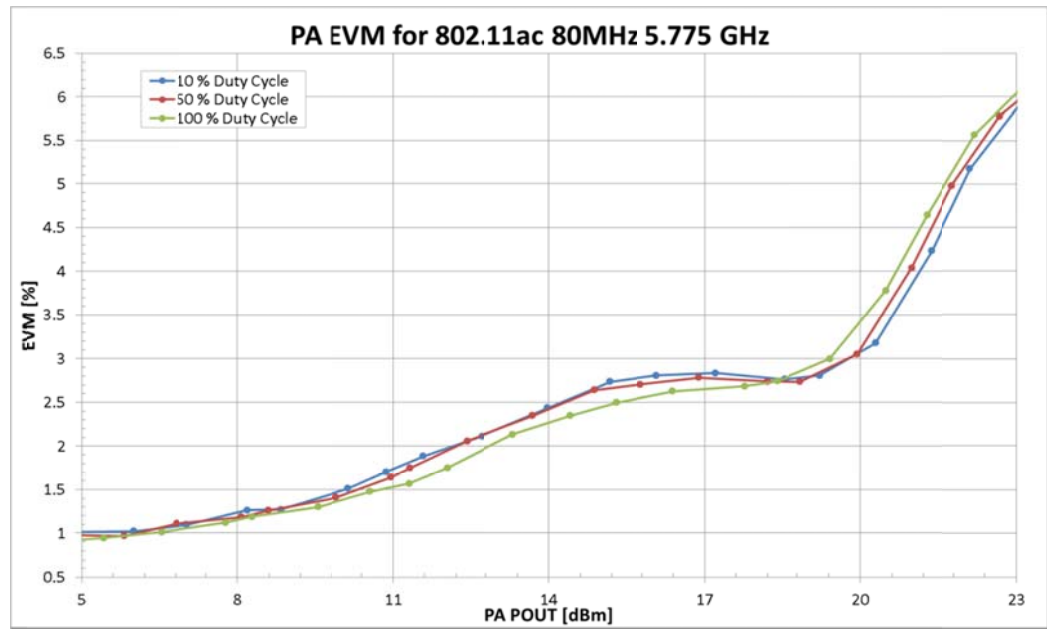

Figure 4) PA Dynamic EVM versus Duty Cycle

DIGITAL PRE-DISTORTION

Improving linearity within the PA at high output power is a challenge. Digital pre-distortion (DPD) is one technique that is used to essentially remove distortion by digital signal processing techniques. Software tools simplify and automate DPD for a combined VSA/VSG test system such as the ZT8201 RF Test Set. Essentially, software models are used to measure the nonlinearity of the PA with the VSA, and create an inverse operation that is applied to the VSG. When DPD compensation is complete, a predistorted VSG RF signal is applied to the PA which effectively linearizes the PA output.

Some 802.11ac WLAN transceiver chip sets employ DPD techniques to improve PA linearity. In order to quantify the improvement that will be achieved in-circuit with DPD, test equipment must be able to perform DPD during PA characterization. Along with the ZT8201 RF Test Set and ZProtocol™ WLAN software, ZTEC Instruments' DPD software tool and corresponding example code provide a quick and easy method to evaluate DPD for a PA or transmitter design. Because DPD algorithms require the VSG/VSA instruments to capture multiple adjacent channels, a wide measurement bandwidth such as that of the ZT8201 RF Test Set is required for DPD applications.

Figure 5 shows the improvement that DPD has upon the adjacent channel leakage due to non-linear distortion as the PA operates within its non-linear region. Even more important is the EVM improvement that can be accomplished with DPD as shown in figure 6. Both graphs depict actual data taken with the ZT8201 RF Test Set using the ZProtocol™ WLAN and DPD software.

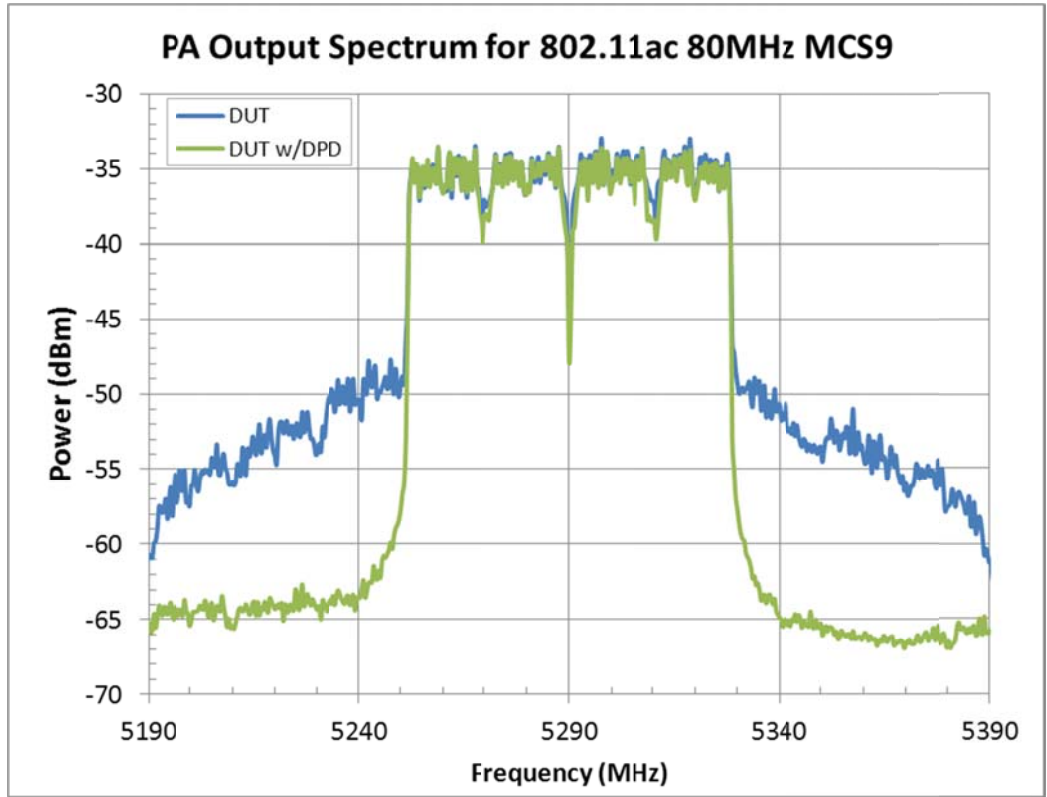

Figure 5) PA Adjacent Channel Leakage Reduction with DPD

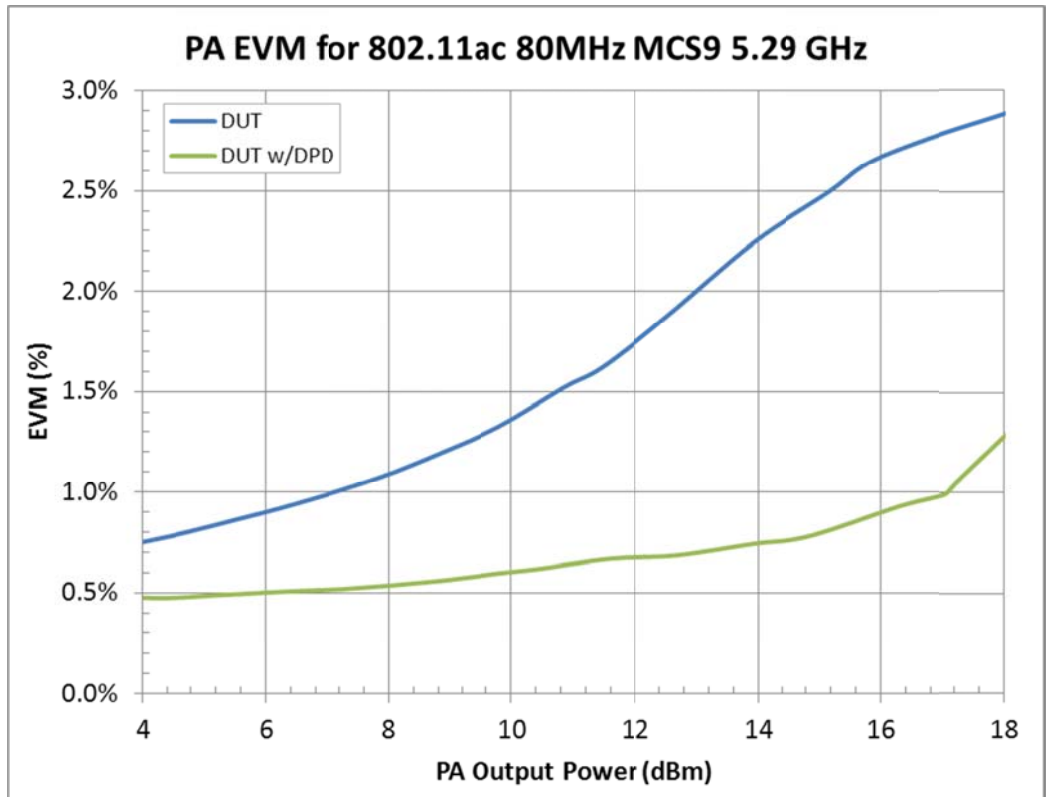

Figure 6) PA EVM Improvement with DPD

TEST EQUIPMENT

For 802.11ac testing, the noise floor, phase noise, intermodulation distortion, and in-band spurious signals of the test equipment must be minimized to avoid degradation of the measured PA EVM performance. Figure 7 shows the effects of test equipment residual EVM on the measured PA DUT EVM.

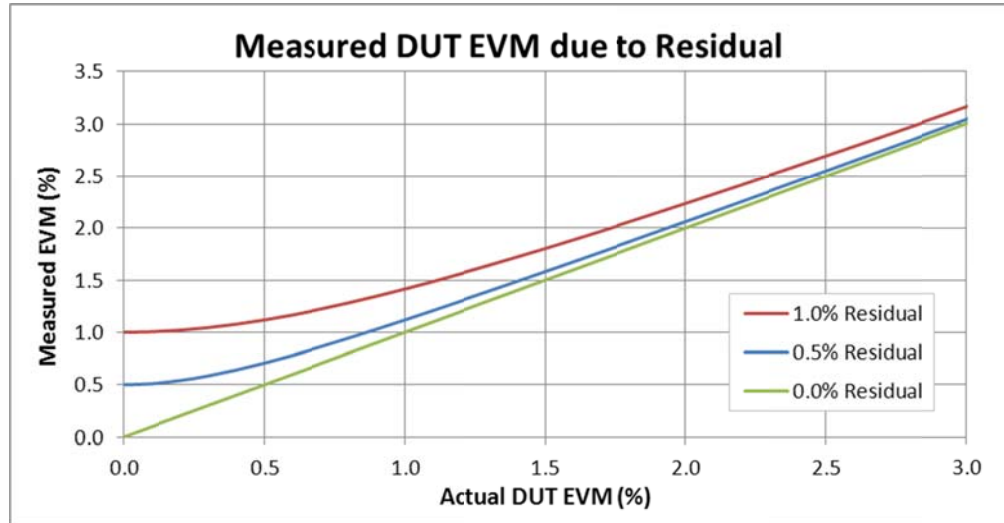

Figure 7) Effects of Test Equipment Residual EVM on Measured DUT EVM

As discussed throughout this paper, the ZT8201 RF Test Set shown in figure 8 is comprised of a 6 GHz VSG/VSA combination with measurement bandwidths up to 160 MHz [6-7]. Along with the wide measurement bandwidth, the ZT8201 RF Test Set provides the low noise and distortion necessary for characterization and testing of 802.11ac devices. The ZT8201 RF Test Set provides an exceptional loop-back residual EVM floor as low as 0.3% for 20MHz 802.11ac and 0.7% for 160 MHz 802.11ac (phase tracking on, preamble-pilot-data equalization). In addition, the ZT8221 RF Test Set which adds ZT8801 LO modules achieves a residual EVM floor as low as 0.2% for 20MHz 802.11ac and 0.5% for 160 MHz 802.11ac.



Figure 8) ZT8201 PXI or PXIe RF Test Set

The ZProtocol™ WLAN software toolkit includes an intuitive graphical user interface (GUI) shown in figure 9 and comprehensive C/C++/LabVIEW software drivers for ease of automation. In combination with the ZProtocol™ WLAN software, the ZT8201 RF Test Set offers a complete solution for 802.11 testing covering all aspects of the WLAN protocols including:

- All Modulation Bandwidths: 160 MHz, 80 MHz, 40 MHz & 20 MHz
- All Modulation Coding Schemes (MCS) and Bit Rates: BPSK to 256QAM
- All Channel Frequencies: 2.4 GHz and 5 GHz bands
- MIMO Streams: X2 to X8

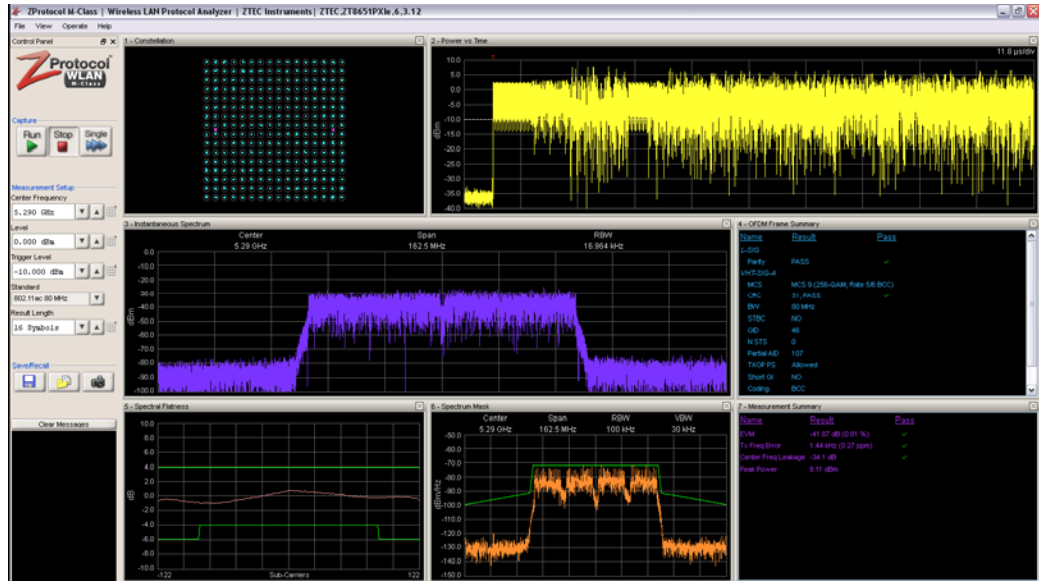

Figure 9) ZProtocol™ WLAN Test Software GUI

Example automation code provides a valuable reference to demonstrate the automated use case and to allow users to begin characterization or design verification with little additional programming or integration. All of the specific PA tests described within this paper are available as example code that can be downloaded from the ZTEC Instruments website.

CONCLUSION

This paper examines the demands that the new 802.11ac WLAN standard places upon the design validation, characterization and testing of power amplifiers (PA). With the EVM contribution of the PA limited for 802.11ac to around 1.5%, greater linearity and dynamic range requirements are needed for the PA and the RF test equipment. This paper defines a number of techniques that assist in test equipment optimization for PA testing for 802.11ac. These techniques are used with the ZT8201 RF Test Set and ZProtocol™ WLAN software to provide a complete solution for qualifying PA performance for operation within an 802.11ac WLAN transmitter design.

REFERENCES

- [1] IEEE 802.11 Standards. [online] available: <http://standards.ieee.org/findstds/standard/802.11-2012.html>
- [2] E. Acar, S. Ozev, and K. Redmond, "Enhanced Error Vector Magnitude (EVM) Measurements for Testing WLAN Transceivers", *Proc. ICCAD 2006*.
- [3] C. D. Ziomek and M. T. Hunter, "Extending the Useable Range of Error Vector Magnitude Testing" [online] available: http://www.ztecinstruments.com/zconnect/wp-content/uploads/2012/03/EVM_Optimization.pdf
- [4] David Guo, "Power Amplifier and Front End Module Requirements for IEEE 802.11n Applications", *High Frequency Electronics*, September 2011.
- [5] Sang-Woong Yoon, "Static and Dynamic Error Vector Magnitude Behavior of 2.4-GHz Power Amplifier", *IEEE Transactions on Microwave Theory and Techniques*, April 2007.
- [6] ZTEC Instruments, "ZT8650 Series Vector Signal Analyzer Specifications" [online] available: <http://www.ztecinstruments.com/products/rf-test-equipment/series/ZT8650/>
- [7] ZTEC Instruments, "ZT8750 Series Vector Signal Generator Specifications" [online] available: <http://www.ztecinstruments.com/products/rf-test-equipment/series/ZT8750/>